

Article number: 2310303125ESD

Description: E+G Antistatic base for levelling elements
LV.A-60-14-M8x68-ESD-C

Measures

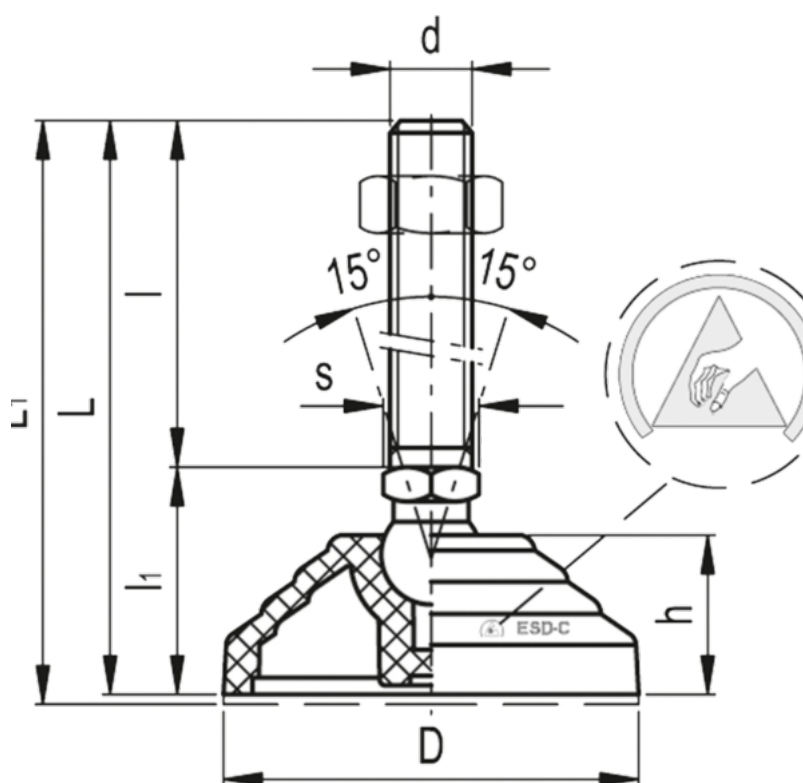

Articulation = 14
D = 60
d = M8
h = 24
l = -
l1 = -
L = 101
Max load = 14000

s = 14
Weight in (g) = 74